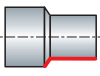
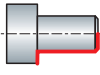

### External and internal turning

General turning

Applications sketch map of turning tools

External turning	Tool holder type						
	DTJNR/L□□	DSBNR/L□□	PCBNR/L□□	PSBNR/L□□	PSSNR/L□□	PTGNR/L□□	PTTNR/L□□
	SCACR/L□□	SSBCR/L□□	SSSCR/L□□	STACR/L□□	STGCR/L□□	STECR/L□□	SWACR/L□□

External and end surface turning	Tool holder type	
	DCLCR/L□□	DWLNRL□□
	PCLNR/L□□	PWLNRL□□
	SCLCR/L□□	

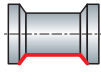

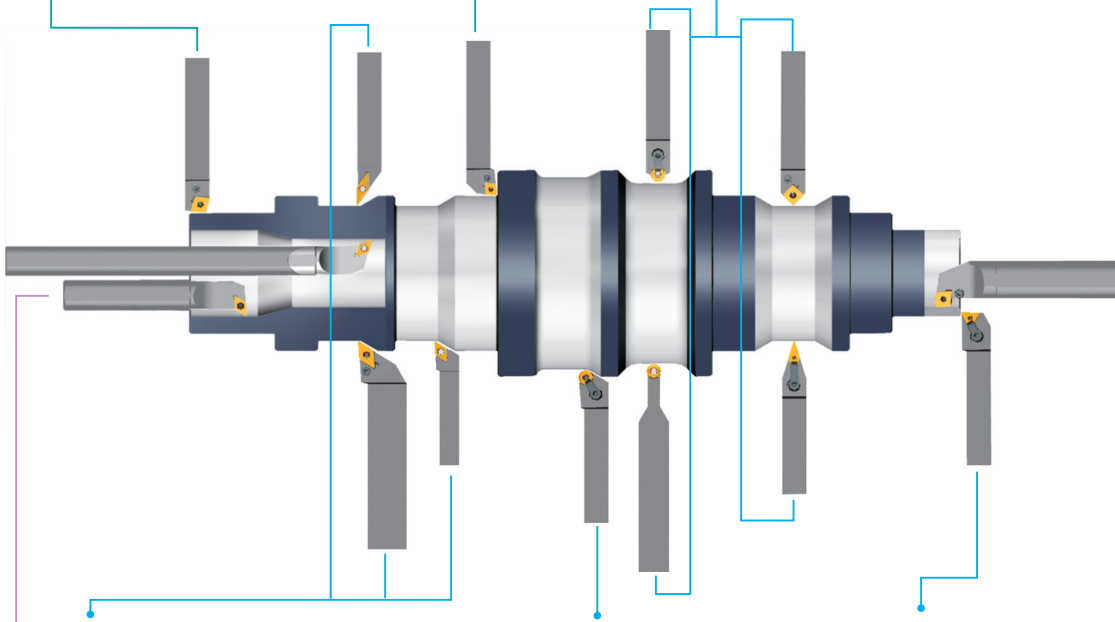
Profile turning	Tool holder type			
	DVVNN□□	PDPNN□□	PSDNN□□	SDNCN□□
	SVVBN□□	SVVCN□□	SSDCN□□	SRDCN□□
	CKNNR/L□□			

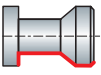

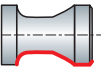
Profile turning	Tool holder type		
	DDJNR/L□□	DVJNR/L□□	PDJNR/L□□
	SDACR/L□□	SDJCR/L□□	SVABR/L□□
	SVJBR/L□□	SVJCR/L□□	CKJNR/L□□

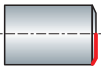
Profile turning	Tool holder type
	SRGCR/L□□

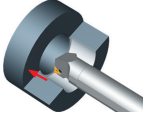
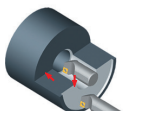
End surface turning	Tool holder type	
	PSKNR/L□□	PTFNR/L□□
	SSKCR/L□□	STFCR/L□□

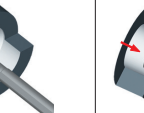
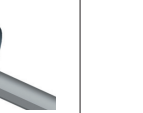
Tool holders for internal turning (Steel tool shank)						
	S□-PSKNR/L□	S□-PCLNR/L□	S□-PDPNR/L□	S□-PDUNR/L□	S□-SDQCR/L□	S□-SDZCR/L□
	S□-PTFNR/L□	S□-PWLNR/L□		S□-SDUCR/L□	S□-SDQPR/L□	
	S□-SCFCR□	S□-SCLCR/L□		S□-SDUNR/L□	S□-SVQBR/L□	
	S□-SSKCR/L□	S□-SCLPR/L□		S□-SDUPR/L□	S□-SVQCR/L□	
	S□-STFCR/L□			S□-SVUBR/L□		
S□-STUPR/L□			S□-SVUCR/L□			

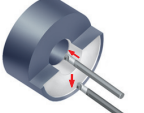
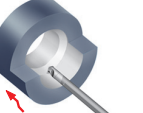
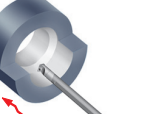
Tool holders for internal turning (Cemented carbide tool shank)				
	C□-STUPR/L□	C□-SCLPR/L□	C□-SDUPR/L□	C□-SDQPR/L□
		C□-SVUCR/L□	C□-SVQCR/L□	

### ● Parting, grooving and threading tools

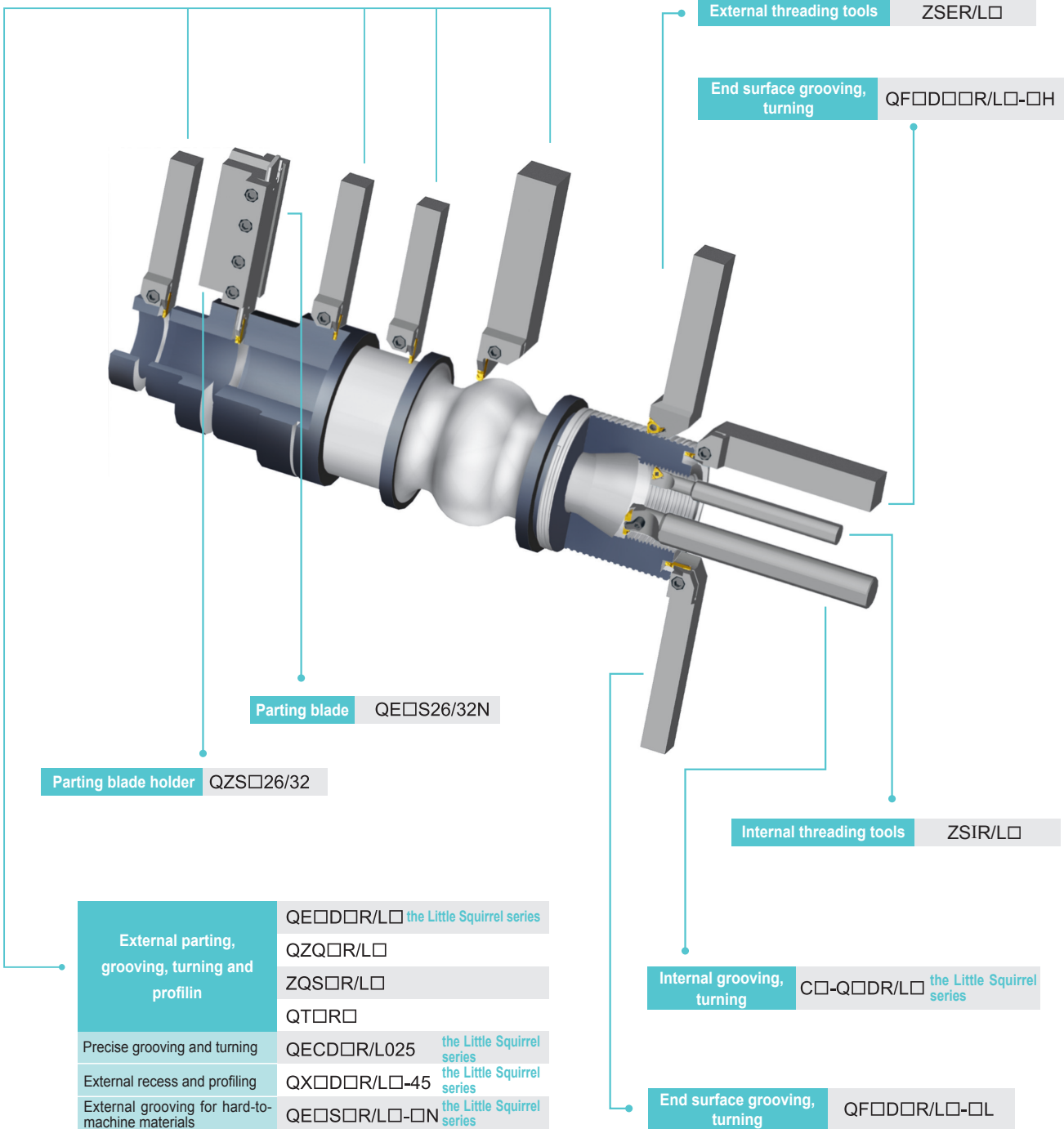

General turning Applications sketch map of turning tools